

Circuit Protection	Code
Fuse	F
MCB	CR



NEMA L6-30P

30A model :	Circuit Protection
DV32C13-30A-WSi/ F _L630/3 B -1	Resettable Fuse x 4
DV32C13-30A-WSi/ CR _L630/3 T -1	1-pole MCB x 4

Input Rating : 30Amp, 208V
 Cordset : 10 feet UL SJT 10 AWG cordset
 Protection : 16A resettable fuse or 16A hydraulic MCB x 4
 PDU I : < **Circuit A** > Output 12A max., C13 #1-8
 < **Circuit B** > Output 12A max., C13 #9-16
 PDU II : < **Circuit A** > Output 12A max., C13 #1-8
 < **Circuit B** > Output 12A max., C13 #9-16
 Weight : Net 27.5 lb / Gross 31.9 lb

PDU Feed	Code
Bottom	B
Top	T



NEMA L6-20P

20A model :	Circuit Protection
DV32C13-20A-WSi/ F _L620/3 B -1	Resettable Fuse x 2
DV32C13-20A-WSi/ CR _L620/3 T -1	1-pole MCB x 2

Input Rating : 20Amp, 208V
 Cordset : 10 feet UL SJT 12 AWG cordset
 Protection : 20A resettable fuse or 20A hydraulic MCB x 2
 PDU I : Output 16A max., C13 #1-16
 PDU II : Output 16A max., C13 #1-16
 Weight : Net 27.5 lb / Gross 31.9 lb

Operating Temperature : -5 to 60 °C
 Storage Temperature : -25 to 65 °C
 Operating Altitude : 0 to 2,000 m
 Storage Altitude : 0 to 15,000 m
 Humidity : 8 to 95% RH, non-condensing

Meter Features (WSi Switched PDU + Outlet Measurement)

Local Display : Field replaceable 2.8" color LCD with touchscreen
 Bank Measurement : Current (A), Energy (kWh), Voltage (V) & Power factor
 Outlet Measurement : Current (A), Energy (kWh)
 Outlet Control : Outlet Switch ON / OFF
 Accuracy : ±1% Billing-grade
 IP Access : via IP dongle, one IP Access up to 16 PDU Levels
 Cascade : Up to 16 PDU under single IP address via IP dongle
 SNMP : V2 / V3 via IP dongle
 Sensor Port x 2 : Temp. Sensor / Temp. + Humid. Sensor

EMC Compliance : FCC Part 15 Subpart B certified
 Safety Compliance : cTUVus Mark to UL 60950-1:2007/R:2014-10
 CAN/CSA-C22.2 No. 60950-1:2007/A2:2014-10
 UL 62368-1:2014
 CAN/CSA-C22.2 No. 62368-1:2014
 UL 60730-1 Ed.5 (2016)

Environment Compliance : RoHS2 & REACH

Product Dimension : 3.3 (W) x 3.5 (D) x 65 (H) inch
 Packing dimension : 4.3 (W) x 10.6 (D) x 80.4 (H) inch

Lockable IEC Outlet

- Patented design for InfraPower PDU



C13 Outlet



C19 Outlet

Lockable IEC Cable

- Patented design of InfraPower PDU
- Low cost, easy to lock & secure
- Proprietary for lockable IEC outlet
- Applicable to standard IEC outlet
- 6 colors & 3 lengths available
- Custom color & length on request
- VDE & ENEC approval

C13 - C14

H05VV-F 3G 0.75mm²

Cable Color	0.5M	1M	2M
Black	✓	✓	✓
Grey	✓	✓	✓
Red	✓	✓	✓
Blue	✓	✓	✓
Green	✓	✓	✓
Orange	✓	✓	✓



C19 - C20

H05VV-F 3G 1.5mm²

Cable Color	1M	2M
Black	✓	✓
Grey	✓	✓
Red	✓	✓
Blue	✓	✓
Green	✓	✓
Orange	✓	✓



C13 - C14

lockable cable

C19 - C20

- ✓ low cost
- ✓ easy to lock
- ✓ secure



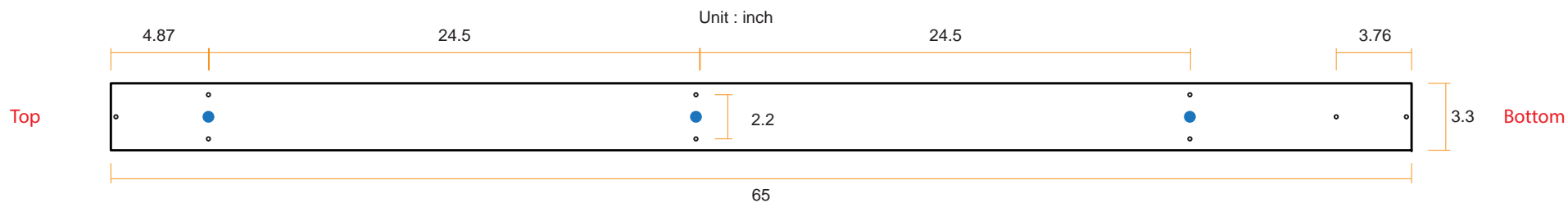
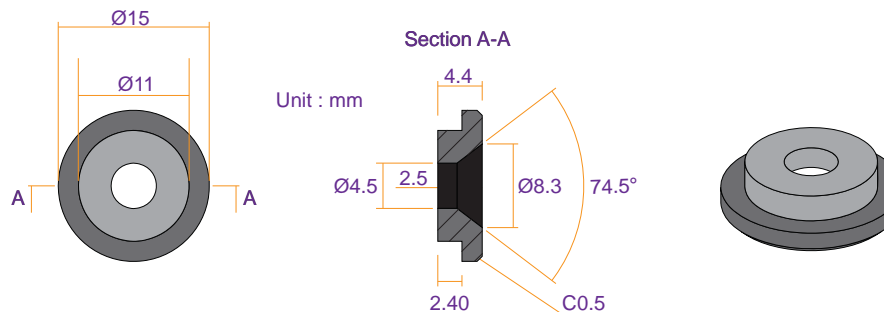

VMS Mounting Button

 x 3 +  x 3
M4 Screw
 - Flat head
 - M4x10mm
PEG



VMB Mounting Bracket

 x 4 +  x 2
M3.2 Screw
 - Flat head
 - M3.2x6mm
Bracket

